

Abstechen :

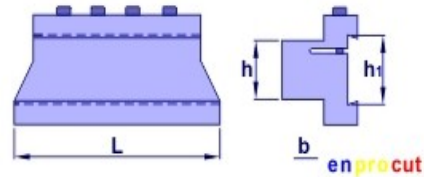

Bestellcode	bxh	L	h1	€/Stck
EGST1916	16x16	76	19	46,50
EGST2620	20x20	87	26	55,50
EGST2625	25x25	87	26	55,50
EGST3220	20x20	100	32	57,50
EGST3225	25x25	100	32	57,50

Bestellcode	Leisten-Höhe	Schneidenbreite	Länge	€/Stck
IH19-2	19	2,2	110	25,90
IH26-2	26	2,2	110	29,90
IH26-3	26	3,1	110	29,90
IH26-4	26	4,1	110	29,90
IH32-2	32	2,2	150	29,90
IH32-3	32	3,1	150	29,90
IH32-4	32	4,1	150	29,90

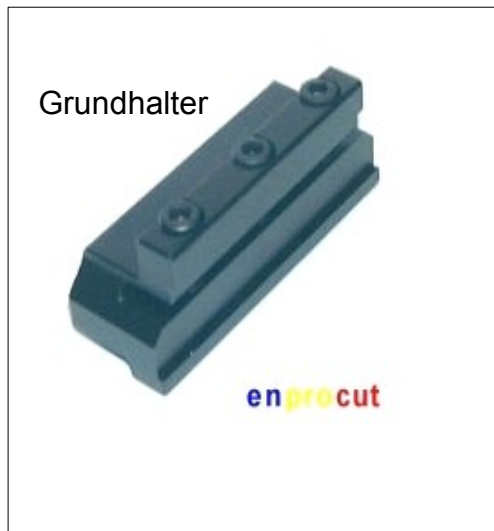

Bestellcode	Stechbreite	€/Stck
EGTN2-TIN	2,2	3,90
EGTN3-TIN	3,1	4,10
EGN4-TIN	4,1	4,50

Abstechen · Einstechen · Stechdrehen · Profilstechen :

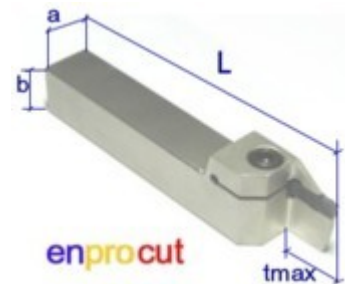

Bestellcode	bx a	L	s	tmax	€/Stck
EP-S-1616R/L-S25-17	16x16	125	2,5	17	48,50
EP-S-2020R/L-S25-17	20x20	125	2,5	17	52,50
EP-S-2525R/L-S25-17	25x25	150	2,5	17	55,50
EP-S-2020R/L-S30-20	20x20	125	3,0	20	48,50
EP-S-2525R/L-S30-21	25x25	150	3,0	21	49,50
EP-S-2020R/L-S40-22	20x20	125	4,0	22	48,50
EP-S-2525R/L-S40-25	25x25	150	4,0	25	49,50

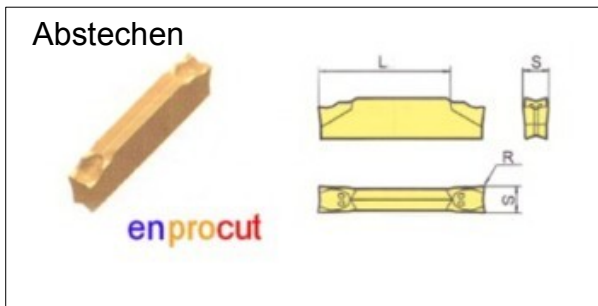

Bestellcode	Stechbreite	R	€/Stck
EP-S2-2502-M-PMK	2,5	0,2	5,80
EP-S2-3002-M-PMK	3,0	0,2	6,20
EP-S2-4002-M-PMK	4,0	0,2	6,60

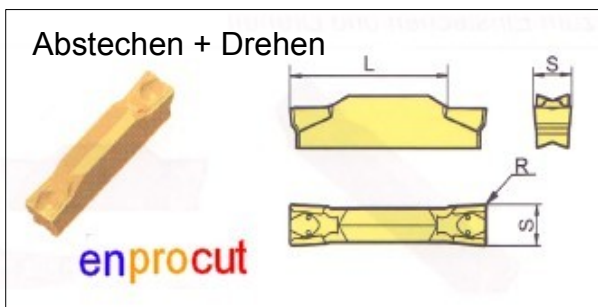

Bestellcode	Stechbreite	R	€/Stck
EP-D2-2503-M-PMK	2,5	0,3	5,80
EP-D2-3003-M-PMK	3,0	0,3	6,20
EP-D2-4004-M-PMK	4,0	0,4	6,60

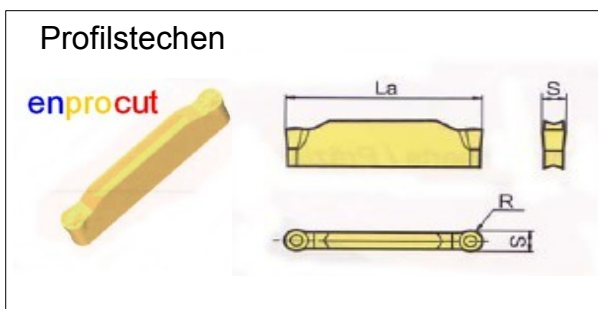

Bestellcode	Stechbreite	R	€/Stck
EP-R2-250 -M-PMK	2,5	1,25	5,80
EP-R2-300 -M-PMK	3,0	1,50	6,20
EP-R2-400 -M-PMK	4,0	2,00	6,65

Abstechen · Einstechen von Ringnuten:

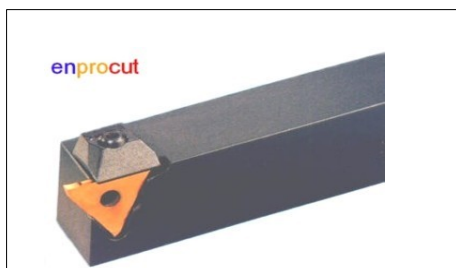

Bestellcode	bxh	L	s=WSP	€/Stck
EP-01-2020R/L	20x20	125	0,5-1,9	49,50
EP-02-2020R/L	20x20	125	1,9-2,9	49,50



Bestellcode	Nut Nennmaß	Schneidenbreite	€/Stck
EP-T3-0160.00TIN9	1,60	1,74	10,90
EP-T3-0215.00TIN9	2,15	2,29	9,90
EP-T3-0265.00TIN9	2,65	2,79	10,90

Einstechen · Radius für Innen- und Außen

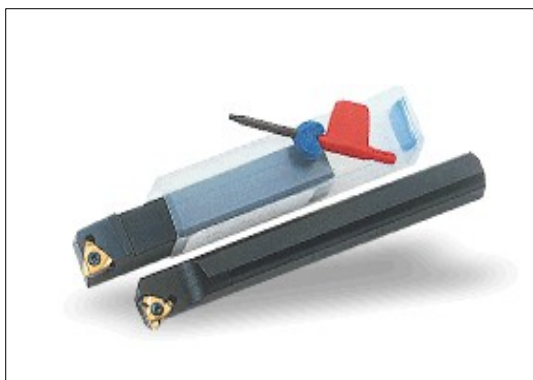

Vorteil ! Es können die Standard-Klemmhalter für Gewindedrehen verwendet werden

Zur Kompensierung des Anstellwinkels 1,5° wird Eine Unterlegplatte benötigt !

Bestellcode	bxh	L	s=WSP	€/Stck
SER 2020K16	20x20	125	0,5-1,9	53,80
Unterlegplatte :				
AE16-0				6,80



Bestellcode	Stechbreite	R	€/Stck
16ER/IL R0,50 TIN	1,0	0,50	11,95
16ER/IL R0,60 TIN	1,2	0,60	11,95
16ER/IL R0,90 TIN	1,8	0,90	11,95
16ER/IL R1,00 TIN	2,0	1,00	11,95
16ER/IL R1,10 TIN	2,2	1,10	11,95
16ER/IL R1,20 TIN	2,4	1,20	11,95



* alle Preise gelten zzgl. MwSt und sind freibleibend, vorbehaltlich unserer Bestätigung.
 ** Preisstellung für Lieferung ab Lager ENPRO, Versandkosten unter www.enpro-gmbh.de

www.enpro-gmbh.de

ENPRO Engineering + Production GmbH Allee 1 a D – 22941 Jersbek
 Telefon : 04532- 400371 Fax : 04532- 400386 E-Mail : info@enpro-gmbh.de